

增加
Flow increase
for C.W. turning

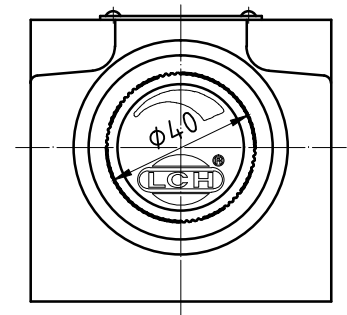
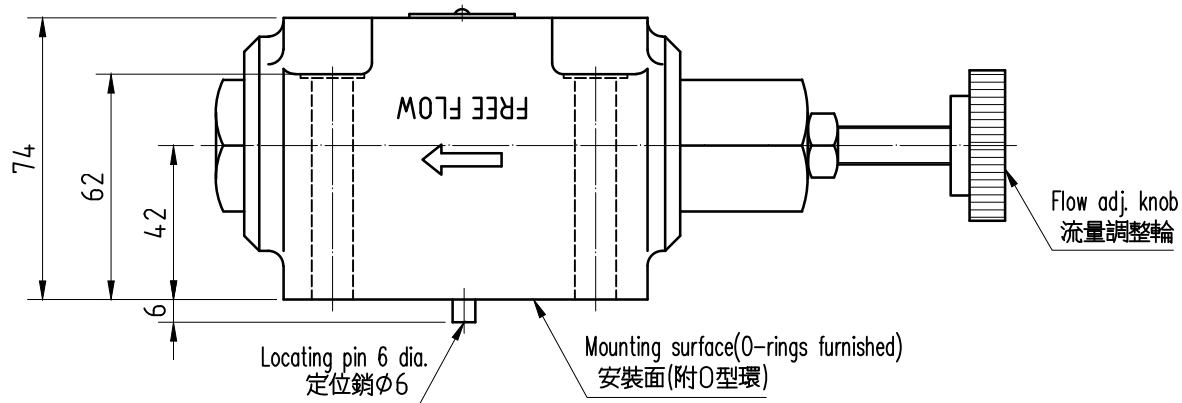

MODE: SRCG-06
單位:mm Unit:mm