

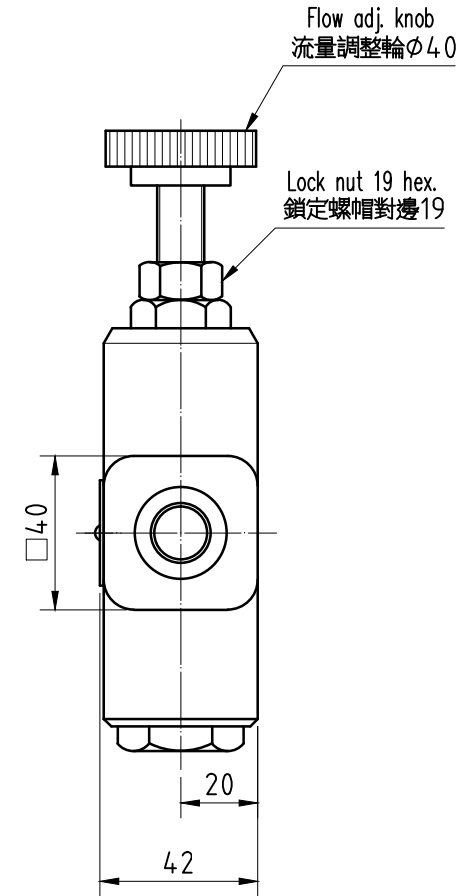

增加
Flow increase
for C.W. turning

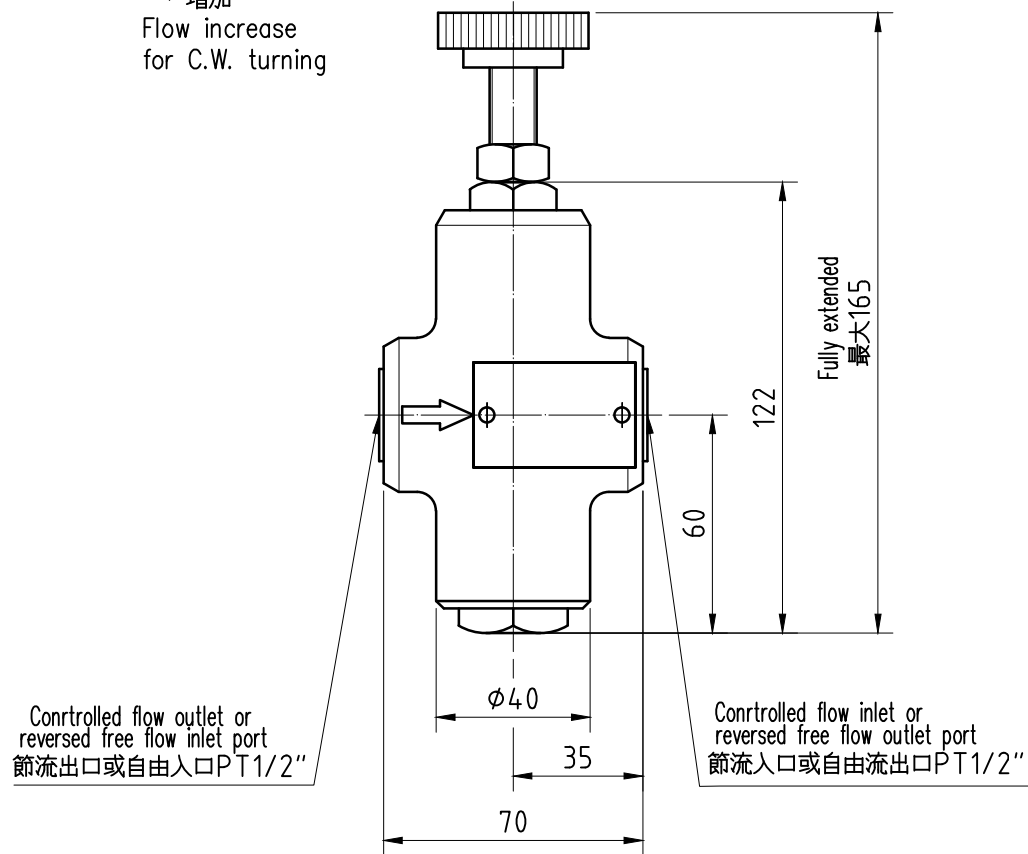

MODE: SRCT-04
單位:mm Unit:mm